

PICAXE-M2 Information

Introducing the **new generation PICAXE-M2** parts for education...
... more memory capacity and features at no extra cost!

The new **PICAXE-08M2**, **14M2**, **18M2** and **20M2** microcontrollers build on the pedigree of the ever popular PICAXE microcontrollers by adding these **new and improved features at no extra cost:**

- Almost every pin is **individually configurable**, so, for instance, the 18M2 can now have 13 outputs instead of 8 – the choice is yours! Therefore M2 chips can be used in either the ‘traditional’ fixed pin format or the new flexible ‘user configured’ format.
- Many extra ADC channels are now also available on other pins, with new support for **touch sensor inputs**.
- The serial input pins (and reset on 18M2) can now be used as 1 or 2 **extra input pins**, giving up to 2 more general purpose input pins for your project. New software ‘reset’ command is available if a reset is required.
- The **08M2** is now a much more powerful 8 pin option, with all the features of the larger pin count devices such as large memory capacity, parallel tasks and advanced hardware features such as touch sensors, SR latch, internal temperature sensor and I2C interfacing.

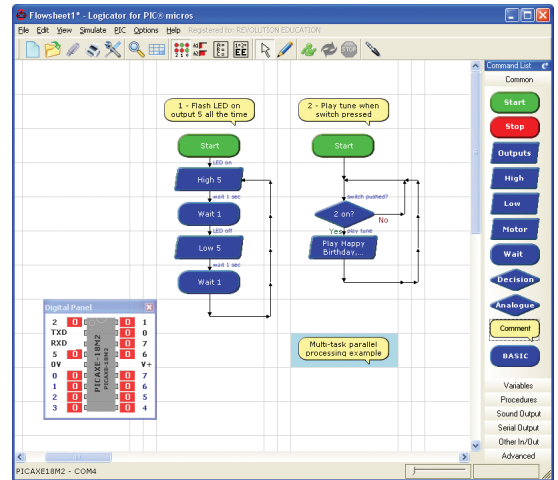

PICAXE-08M2

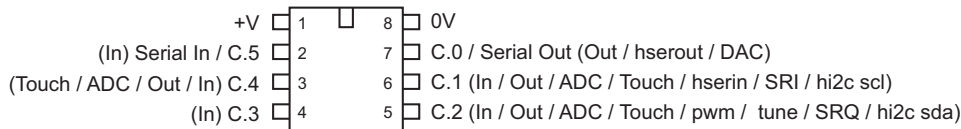

- The M2 parts can now run either **four or eight separate tasks in parallel**, allowing, for instance, a Logicator flowsheet to contain 4 separate start cells and 4 separate flowchart tasks. Multi tasking is also supported in BASIC program listings.
- The M2 parts replaces all of the A/M/X parts and so give a much higher memory capacity (**2048 bytes, up to 1800 lines of program**) than the older 256 byte M parts, - so as an example the 08M2 gives **8x the memory capacity** of the older 08M for no extra cost (at educational full tube pricing).
- Fully **backwards compatible** with all existing PICAXE project boards and most programs written for any older PICAXE part.
- New lower, down to **1.8V operation** now makes the M2 ideal for use with 3V battery packs - save the cost of one battery!
- **Twice as many (now 28) general purpose byte variables**, with up to a total of up to 512 bytes of RAM.
- New **‘time’ variable** counts elapsed seconds.
- **256 bytes** of non-volatile data EEPROM memory.
- Faster internal resonator (**up to 32MHz**) means up to 8x faster program processing.
- Full support for common features such as **ring tone tunes, servos, digital temperature sensors** and **infra-red** input and output on any pin.
- Full support for advanced features like DAC, SR latch, hardware serial commands (for much faster baud rates), **i2c memory devices** and PWM control of motors.
- The M2 parts are new custom parts factory manufactured by Microchip Inc. solely for Revolution Education and so are **factory engraved with the full PICAXE-M2 name** – no more confusing PIC numbers for students to decipher!

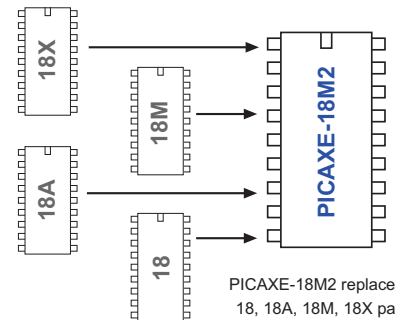
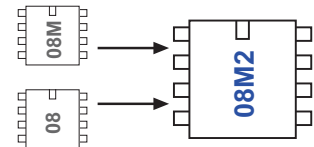

PICAXE-18M2 replaces all 18, 18A, 18M, 18X parts.

PICAXE M2 Product Briefing.

Introduction

This product briefing is designed to inform existing PICAXE users about the extra and enhanced programming commands and features of the exciting new M2 range of PICAXE microcontrollers. Further details about each command and feature are available in the updated PICAXE Manuals (v7.7 or later). Programming Editor software must be v5.4.0 or greater.

Note that M2 parts are laser engraved with the full PICAXE name for easier identification.

Pinouts

PICAXE-08M2

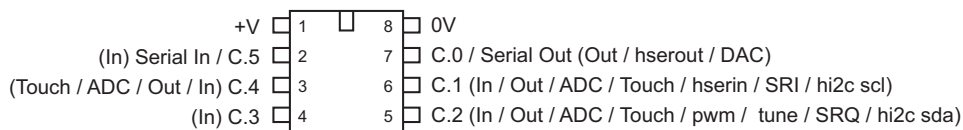

PICAXE-14M2

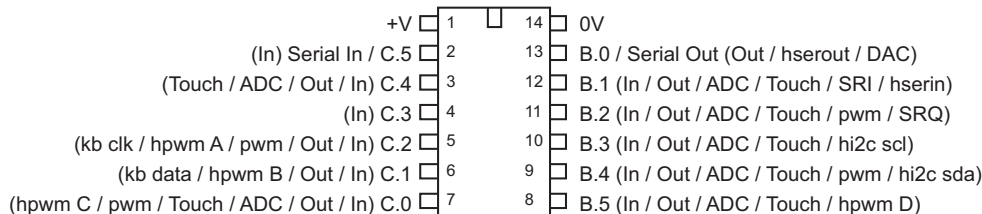

PICAXE-18M2

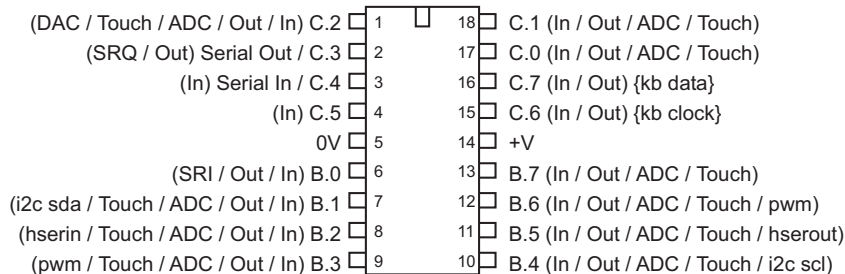

PICAXE-20M2

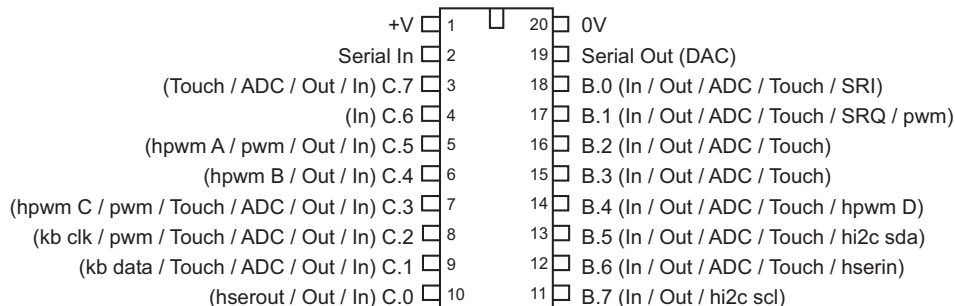

Example Part Comparison (08M2):

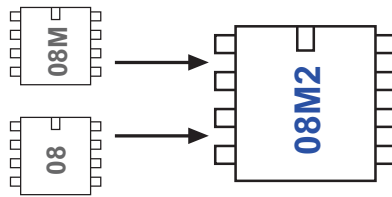

PICAXE Feature	BASIC command	08M2	08M	08
Memory Capacity (bytes)		2048	256	128
Max. Memory Capacity (lines)		1800	220	110
Available Input / Output Pins		6	5	5
Operating Voltage (V)		2.3 - 5	3 - 5	3 - 5
Parallel multi-tasking (starts)	start	4	1	1
General 'B' Variables (bytes)		28	14	14
Total Available RAM (bytes)	peek / poke	128	62	0
Special Word (S_W) Variables		8	0	0
Data EEPROM (bytes)	read / write	256	256-P	128-P
Max. Operating Speed (MHz)	setfreq	32	8	4
Default Operating Speed (MHz)		4	4	4
Gosub Sub Procedures	gosub	255	15	15
Sub Procedure Stack	return	8	4	4
Analogue (ADC) Inputs	readadc	3	3	1
Touch Sensor Inputs	touch	3	0	0
Elapsed Time Variable	time	✓	✗	✗
Servo Support	servo	✓	✓	✗
Musical Ringtone Tune Support	tune	✓	✓	✗
I2C Interfacing	hi2cin / hi2cout	✓	✗	✗
Infra-red Input and Output	irin / irout	✓	✓	✗
Serial & Infra-red Timeouts	serin / irin	✓	✗	✗
Software Serial Support	serin / serout	✓	✓	✓
Hardware Serial Support	hserin / hserout	✓	✗	✗
Hardware SR Latch	srlatch	✓	✗	✗
Hardware DAC and FVR	dacsetup	✓	✗	✗
Digital Temp. Sensor Support	readtemp	✓	✓	✗
Internal Temperature Sensor	readinternaltemp	✓	✗	✗
Indirect bptr RAM access	@bptr	✓	✗	✗
Real-life (In Circuit) Simulation		✓	✗	✗
Factory Engraved PICAXE Name		✓	✗	✗

Parallel Tasks

One of the new features of the M2 series is that they can run up to 8 program tasks in parallel. This simplifies programming for younger students, particularly when using the Logicator flowcharting software.

For more details about this feature please see the 'Parallel Task Processing' section in part 1 of the PICAXE manual (v7.7 or later).

See: restart, suspend, resume

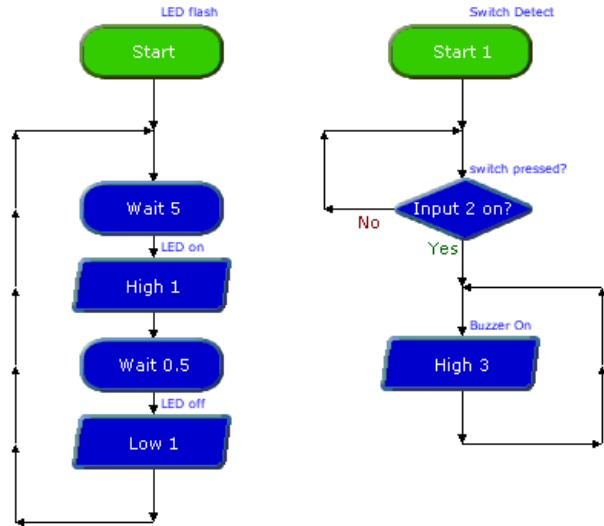

Inputs and Outputs

One of the key new features of the M2 series is that almost every pin is configurable as input or output. This creates much more flexibility. Naturally the pins can be configured to the traditional PICAXE layout if desired.

The M2 range have up to 16 configurable input/output pins, which are arranged in 2 ports, labelled B and C. Each port has up to 8 pins (0-7). See the pinout diagrams on the previous page for the specific pin layouts.

Pins are referred to by the notation format PORT.BIT e.g.

```
high B.0
count C.2,1000,w1
```

When using input pin variables (e.g. within if..then commands) the notation pinPORT.BIT is used as the variable name.

```
if pinC.3 = 1 then
```

The whole port can be read or written by using the variable name pinsX

```
let b1 = pinsC           ; read the input pins
let b1 = outpinsB       ; read the state of the output pins
let outpinsB = %10101010 ; control the output pins
```

All pins (with the exception of the download serial output pin) are configured as digital inputs at power-up. Most output commands (high, low, pulsout, serout etc.) automatically convert the pin to an output. However the configuration of the pins can also be controlled by the dirsX variables or the input/output/reverse commands.

```
let dirsB = %11110000
input C.1
output B.2
```

Memory Capacity

The M2 parts now have up to 2048 bytes of program memory, which is 8x larger than the older M parts. They also contain 256 bytes of data memory (read/write/eprom commands).

On the 14M2, 20M2 and 18M2+ the program memory and data memory are completely separate (2048 + 256). Due to more limited silicon resources on the 08M2/(older)18M2 the upper 256 bytes are shared between program and data (2048 in total). Therefore with programs that are under 1792 bytes long all 256 bytes of data memory are available. Very long programs (over 1792 bytes) start to reduce the amount of data memory available.

See: eeprom, read, write

Variables

On the M2 parts there are now up to 512 general purpose variables. 28 of these, known as b0 to b27, can be used directly in any command (as with other PICAXE parts). This is double the older M/X number of bX variables.

All general purpose bytes (0-511) can also be addressed both directly and indirectly.

To directly address the values the peek (read the byte) and poke (write the byte) commands are used. Note that peek and poke are now dedicated to the general purpose variables, to read the microcontroller peripheral registers the new commands peeksfr and pokesfr are used.

To indirectly address the values the virtual variable name '@bptr' is used. @bptr is a variable name that can be used in any command (ie as where a 'b1' variable would be used). However the value of the variable is not fixed (as with b1), but will contain the current value of the byte currently 'pointed to' by the byte pointer (bptr).

The compiler also accepts '@bptrinc' (post increment) and '@bptrdec' (post decrement). Every time the '@bptrinc' variable name is used in a command the value of the byte pointer is automatically incremented by one (ie bptr = bptr+1 occurs automatically after the read/write of the value @bptr). This makes it ideal for storage of a single dimensional array of data.

See: peek, poke, peeksfr, pokesfr

Time Variable

The new word variable 'Time' increments after every second the program has been running. It can count up to 65535 elapsed seconds (approx 18 hours) before overflowing. To reset simply use 'let time = 0'. Time increments every second at both 4MHz and 16MHz. At other clock speeds it will increment differently (e.g. 0.5s at 8MHz).

See: disabletime, enabletime

Analogue Inputs

Many more ADC channels are now available. Using the 'readadc' command automatically configures the pin as an analogue input. The analogue voltage range can be the PICAXE power supply range or an alternate external voltage range. In this case two analogue pins are used to set the positive and/or negative reference for the ADC (see the adconfig command).

M2 parts also have an accurate internal voltage reference (1.024V), for calibration use with monitoring battery powered projects. See the calibadc command for more details.

See: readadc, readadc10, calibadc, calibadc10, adconfig

Touch Sensor Inputs

Each analogue input can now also be used as a touch sensor input for use with PCB touch sensor pads.

See: touch, touch16 (and the 'AXE181' PICAXE-18M2 Touch Sensor Demo board)

DAC and FVR

The M2 parts support a digital-to-analogue converter (DAC) for accurate analogue voltage output. The range of the DAC can be the supply voltage or a reference voltage generated by the Fixed Voltage Reference (FVR) module. This module can be set to generate an accurate 1.024, 2.048, or 4.096V reference.

See: dacsetup, daclevel, readdac, fvrsetup

Low Voltage Operation

The M2 parts have an internal 3.3V silicon die, but also contain an internal Low Drop Out Regulator, which is automatically enabled when required. This means most M2 parts can be used across the entire 1.8 to 5V voltage range (2.3V for 08M2). Input/Output interfacing can be at 3.3V or 5V. Powering from 2xAA cells rather than 3xAA cells is now fully supported. Brownout voltage (if not disabled via disablebod command) is 1.9V.

See: enablebod, disablebod

Clock Frequency

Much higher clock rates are now available. This greatly improves the PICAXE processing speed.

The default power-up operating frequency is 4MHz, using the internal resonator. Alternate internal clock frequencies up to 32MHz are now available – 8x faster than 4MHz!

See: `setfreq`

More I/O Pins

The serial download pins can now be used as general purpose pins. The new reset command replaces the need for a separate external reset pin. Therefore on 18 pin parts leg 4 is now available as another general purpose input pin.

See: `serrxd`, `sertxd`, `disconnect`, `reconnect`, `reset`

Timeout Support

The M2 parts now support timeouts on the serial, infra red and keyboard commands.

See: `serin`, `serrxd`, `irin`, `kbin`

Play/Tune Multiple LED Flash

Multiple outputs can now be programmed to flash in time to play and tune ring-tone commands. The piezo for the tune can be connected to any output pin. All 4 predefined play tunes can be used on any size chip.

See: `play`, `tune`

Servo

The servo command operation has been fully updated and revised, and is now more accurate due to additional 'anti-jitter' coding. Servo operates at either 4 or 16 MHz.

See: `servo`, `servopos`

Infra-red Support

Infra-red input and output can now be used on any pin. Irin input also supports an optional timeout

See: `irin`, `irout` (note `irin` replaces `infrain/infrain2`)

RF Support

14M2, 18M2+ and 20M2 parts now also support Manchester encode RF radio transmission

See: `rfin`, `rfout`

i2c Support

The 08M2, 14M2 and 20M2 parts now also support i2c in addition to the 18M2

See: `hi2csetup`, `hi2cin`, `hi2cout`

More PWM outputs

More PWM output pins are available (up to 4 on the 20M2), see pinout diagrams for more details.

See: `pwmout`, `pwmduy`

Longer Nap Delays

The nap command has an extended number of options, giving longer delay options.

See: `nap`

Internal Input Type / Pullups

Most pins have a weak internal pullup resistor that can be enabled via the 'pullup' command. In addition on the 14M2 and 20M2 parts the inputtype can be selected to be either TTL or ST style on any pin.

See: `pullup`, `inputtype`

Hardware Serial Port

Higher baud rates are now possible via the new hardware serial port.

See: `hsersetup`, `hserout`, `hserin`

SRLatch

The SR latch is a hardware feature that can be used in the background to control the SRQ latch output pin. This can be triggered by the SRI pin to instantly control that output pin, independent of program operation. The latch can also be used to generate a 555 timer style pulsing output.

See: `srlatch`, `srset`, `srreset`

Backwards compatibility with older M programs.

The PICAXE compilers automatically recognise older M/X part program input/output pin notation and the vast majority of programs will therefore run directly without any modification on the newer M2 parts.

This means, for instance, that output commands will process on portB

`high 1` will be automatically processed as `high B.1`

but input commands will process on portC

`count 2, 1000, w1` will be automatically processed as `count C.2, 1000, w1`

However to avoid confusion it is strongly recommended that new programs should always be written using the new PORT.PIN notation.

The main exception to instantly useable older programs is where a 'let pins=' command is used in the old 14M/18M/20M program. In this case add the following new line at the top of the program for M2 use, this sets portB as outputs to match the original M part i/o layout.

```
let dirsB = 255 ; set all portB pins as output
```

Note also that certain older commands have been deprecated as they are replaced with an enhanced alternative. The older command will still be recognised (on chip s that support that particular feature), but use of the replacement command is recommended for enhanced operation.

<code>infrain</code> , <code>infrain2</code>	->	<code>irin</code>
<code>infra</code> (variable)	->	no longer required, but <code>infra</code> is still accepted as a pseudo for b13
<code>infraout</code>	->	<code>irout</code>
<code>keyin</code>	->	<code>kbin</code>
<code>keyled</code>	->	<code>kbled</code>
<code>i2cslave</code>	->	<code>hi2csetup</code>
<code>readi2c</code>	->	<code>hi2cin</code>
<code>writei2c</code>	->	<code>hi2cout</code>

M2 Part Comparison

Most features are supported by all 4 sizes of the M2 microcontrollers. However there are a few slight differences between the parts due to the technical design of the silicon resources within the microcontroller:

Feature	PICAXE Command	08M2	18M2	18M2+	14M2	20M2
Voltage Range (V)		2.3-5.5	1.8-5.5	1.8-5.5	1.8-5.5	1.8-5.5
Memory Capacity (bytes)		2048	2048	2048	2048	2048
Parallel Tasks (starts)	resume, suspend	4	4	8	8	8
Max Internal Freq (MHz)	setfreq	32	32	32	32	32
Variables RAM (bytes)	peek, poke @bptr	128	256	512	512	512
Table data (bytes)	table, readtable, tablecopy	-	-	512	512	512
I2C master support	hi2cin, hi2cout, hi2csetup	Yes	Yes	Yes	Yes	Yes
Pwmout channels	pwmout	1	2	2	4	4
Hpwm support	hpwm	No	No	No	Yes	Yes
Keyboard support	kbin, kbled	No	No	Yes	Yes	Yes
RF radio support	rfin, rfout	No	No	Yes	Yes	Yes
Internal temp. sensor	readinternal-temp	Yes	No	Yes	Yes	Yes
Configurable input type	inputtype	No	No	No	Yes	Yes

*18M2 has now been replaced by 18M2+